

IRSA

Ten Rater

CLASS RULES 2018

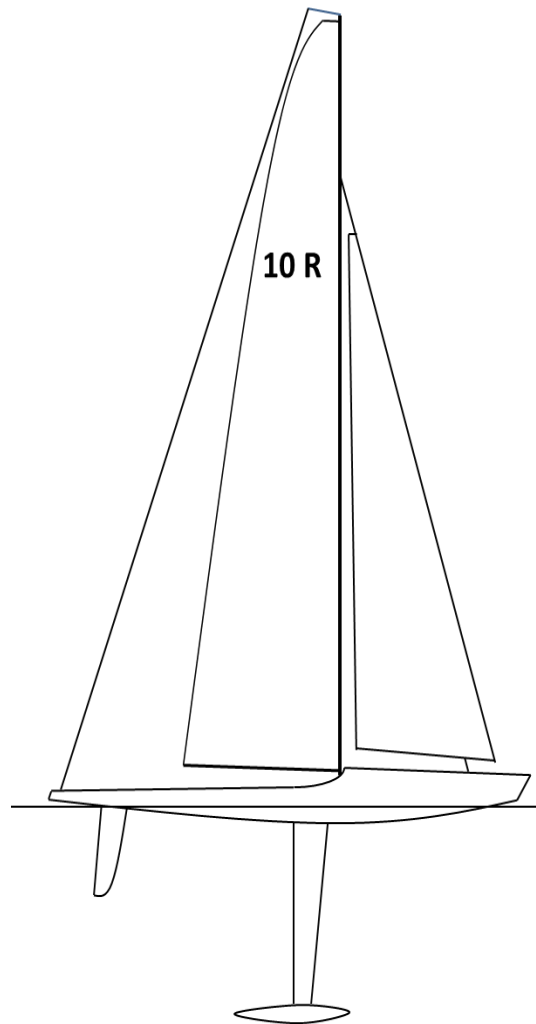

Ten Rater rule is a direct descendant of the Length and Sail Area rule of 1887.
It has been used for models since the 1890s.

INDEX

INTRODUCTION	3
--------------------	---

PART 1 – ADMINISTRATION

Section A – General

A.1 Language	4
A.2 Abbreviations	4
A.3 Authorities.....	4
A.4 Administration of the Class	5
A.5 Sailing Instructions	5
A.6 Class Rules Amendments	5
A.7 Class Rules Interpretation	5
A.8 Hull Registration Numbers	5
A.9 Hull Certification	6
A.10 Validity of Certificate	6
A.11 Compliance with Class Rules ..	6
A.12 Hull Re-Certification	7
A.13 Retention of Certification Documentation	7

Section B – Boat Eligibility

B.1 Class Rules and Certification ..	7
B.2 Class Association Markings	7

PART 2 – REQUIREMENTS AND LIMITATIONS

Section C – Conditions for Racing

C.1 General	8
C.2 Competitor	8
C.3 Advertising	8
C.4 Boat	8
C.5 Hull	9
C.6 Hull Appendages	9
C.7 Rig	9
C.8 Sails	10
C.9 Equipment	10

Section D – Hull

D.1 General	11
D.2 Hull	11

Section E – Hull Appendages

E.1 General	12
E.2 Hull Appendages	12

Section F – Rig

F.1 General	12
F.2 Certified Rig Area	13

Section G – Sails

G.1 General	13
G.2 Certified Sail Area	13

PART 3 – APPENDICES

Section H – Rating and Weight

H.1 Rating Formula	14
H.2 Rating	14
H.3 Weight	14

Section J – Rig Area

J.1 General	14
J.2 Certified Rig Area	14
J.3 Constantly and Evenly Tapered Profiles	15
J.4 Other Profiles	15

Section K – Sail Area

K.1 Certified Sail Area	16
K.2 Soft Sails	16
K.3 Other Sails & Rig Components	17

Section L – Figures

L.1 Spar Measurement	19
L.2 Soft Sail Measurement	20
L.3 Other Sail Measurement	22
L.4 Waterline Limit Marks on Plumb Ended Hulls.....	24
L.5 Calculation of Area A2	25
L.6 Transverse Hull Hollows	26

INTRODUCTION

This introduction only provides an informal background and the IRSA Ten Rater class rules proper begin on the next page.

Certification and alterations

*Ten Rater Class **hulls, hull appendages, rigs and sails** are **certified by certification control**.*

*Ten Rater Class **hulls, hull appendages, rigs and sails** may, after initial **certification control**, only be altered to the extent permitted in Section C of the **class rules**.*

Responsibility

*Owners and competitors should be aware that compliance with rules in Section C is NOT checked as part of the initial **certification control** process.*

*It is the responsibility of the owner and any other person in charge to ensure that a **boat** is maintained to comply with her **class rules** and that her **certificate** remains valid (RRS 78.1).*

Deviations outside of tolerances

*When an **equipment inspector** or **official measurer** acting for the technical committee for an event decides that a **boat** does not comply with the **class rules**, RRS 60.4(a)(2) obliges him to protest the boat.*

*When a protest committee finds that deviations in excess of tolerances specified in the **class rules** are not caused by normal wear and tear and/or do improve the performance of the **boat**, it shall penalise her.*

*When deviations between a **boat's** measurements and her **certificate** cannot be corrected as required by RRS 64.3 (a), a protest committee may consider accepting that the **boat** shall be brought into rating in another configuration before racing again.*

*If a protest committee decides that a **class rule** has been breached deliberately or knowingly by an owner, competitor, or support person it may call a hearing under rule 69.*

Class rules

*The rules regulating the use of equipment during a race are contained in Section C of these **class rules**, in ERS Part I, and in the Racing Rules of Sailing.*

*The **class rules** for the IRSA Ten Rater Class are **open class rules** in which anything not specifically prohibited by the **class rules** is permitted. Individual rules may require, limit, or prohibit as necessary.*

PART 1 – ADMINISTRATION

Section A – General

A.1 LANGUAGE

A.1.1 The official language of the class is English and in case of dispute over translation the English text shall prevail.

A.1.2 The word “shall” is mandatory and the word “may” is permissive.

A.1.3 Except where used in headings;
when a term is printed in “**bold**” the definition in the current ERS applies;
when a term is printed in “*italics*” the definition in the RRS applies; and
when a term is printed “underlined” the definition in these **class rules** applies.

A.1.4 DEFINITIONS

<u>Rig</u>	A rig , excluding any wind indicators, and sail(s) used in combination.
<u>Spar</u>	The main structural part(s) of the rig to, or from, which sails are attached and/or supported.
<u>Datum waterplane</u>	The horizontal plane through points formed by the intersection of the centreplane and the inboard edges of the waterline limit marks .
<u>Certified waterline length</u>	The distance between points formed by the intersection of the centreplane and the inboard edges of the waterline limit marks .
<u>Maximum permitted sail area</u>	The maximum sail area permitted for the <u>certified waterline length</u> .

A.2 ABBREVIATIONS

A.2.1	WS	World Sailing
	IRSA	International Radio Sailing Association
	MNA	WS Member National Authority
	DNM	Designated National Member, IRSA Member
	ICA	International Class Association
	NCA	National Class Association
	ERS	Equipment Rules of Sailing
	RRS	Racing Rules of Sailing

A.3 AUTHORITIES

- A.3.1 Where one does not exist, the functions of the ICA, as specified in these **class rules**, shall be carried out by the IRSA.
- A.3.2 The **class authority** is the IRSA which shall co-operate with the ICA in all matters concerning these **class rules**.
- A.3.3 No legal responsibility with respect to these **class rules**, or accuracy of **certification**, rests with:
- WS;
 - the IRSA;
 - any MNA;
 - any DNM;
 - the ICA;
 - any NCA;
 - any **certification authority**;
 - any **official measurer**.

No claim arising from these **class rules** can be entertained.

- A.3.4 Notwithstanding anything contained herein, the **certification authority** has the authority to withdraw a **certificate** and shall do so on the request of the IRSA.

A.4 ADMINISTRATION OF THE CLASS

- A.4.1 The IRSA has delegated its administrative functions of the class to DNMs. A DNM may delegate part or all of its functions, as stated in these **class rules**, to an NCA.
- A.4.2 In countries where there is no DNM, or the DNM does not wish to administrate the class, its administrative functions as stated in these **class rules** shall be carried out by the ICA which may delegate the administration to an NCA.

A.5 SAILING INSTRUCTIONS

- A.5.1 These **class rules** shall not be varied by sailing instructions except as provided by A.5.2.
- A.5.2 At World or Continental Championships the sailing instructions may vary these **class rules** only with the agreement of the ICA.

A.6 CLASS RULES AMENDMENTS

- A.6.1 Amendments to these **class rules** shall be proposed by the ICA, or a DNM, and require to be approved by the IRSA.

A.7 CLASS RULES INTERPRETATION

- A.7.1 GENERAL

Interpretation of **class rules** shall be made in accordance with the IRSA Regulations.

A.7.2 AT AN EVENT

Any interpretation of **class rules** required at an event may be made by an international jury constituted in accordance with the RRS. Such interpretation shall only be valid during the event and the organising authority shall, as soon as practical after the event, inform the IRSA, the DNM and the ICA.

A.8 HULL REGISTRATION NUMBERS

A.8.1 Registration numbers shall be issued by the **certification authority**.

A.8.2 Registration numbers shall be issued in consecutive order starting at "1".

A.8.3 Each hull shall have a unique registration number which shall include the national letters and the **certification authority's** sequential registration number. Under no circumstances may a registration number be used on a **hull** other than the **hull** on which it was first used.

A.9 HULL CERTIFICATION

A.9.1 For the **certification** of a **hull** all items required by the measurement form(s) to be **certified** shall be **certified** by an **official measurer** and the details entered onto the form(s).

A.9.2 The measurement form(s), and **certification** fee if required, shall be sent to the **certification authority** in the country where the **hull** is to be registered within 4 weeks after completion of **certification**.

A.9.3 Upon receipt of a satisfactorily completed measurement form(s) and **certification** fee if required within the 4 week time limit, the **certification authority** may issue a **certificate**.

A.10 VALIDITY OF CERTIFICATE

A.10.1 A valid **certificate** is issued using the IRSA approved **certification control** documentation in accordance with the procedures in A.9 and A.12. Certificates from other documentation or sources are invalid.

A.10.2 A **certificate** becomes invalid upon:

- (a) a change of ownership;
- (b) withdrawal by the **certification authority**.

A.11 COMPLIANCE WITH CLASS RULES

A.11.1 A **boat** ceases to comply with the **class rules** upon:

- (a) use of equipment that does not comply, or causes the **boat** not to comply, with limitations in the **class rules**;
- (b) use of equipment that does not comply, or that causes the **boat** not to comply, with limitations recorded on the **certificate**;

- (c) alteration or repair of equipment required by the measurement form(s) to be **certified**, except where permitted by the **class rules**;
- (d) a change of **class rules** that causes equipment in use to cease to comply, except where the equipment may comply with the **class rules** in force at the time of its previous **certification**.

A.11.2 A **boat** that has ceased to comply with the **class rules** may be brought into compliance:

- (a) when limitations affecting the equipment are in the **class rules** or on the **certificate**
by an **official measurer** carrying out **certification control** of affected equipment;
- (b) and otherwise
by replacing equipment that does not comply with the **class rules** or **certificate** with equipment that does comply.

A.12 HULL RE-CERTIFICATION

A.12.1 A **hull** may be issued with a new **certificate**, showing dates of re-**certification** and initial **certification** as applicable:

- (a) when a **certificate** becomes invalid upon change of ownership by application of the new owner to the **certification authority** in the country where the **hull** is to be registered. The application shall include the old **certificate** and re-**certification** fee if required. In the case of an imported **hull** the **certification authority** shall request the measurement form(s) from the previous **certification authority** and a new **hull** registration number shall be issued;
- (b) when a **certificate** has been withdrawn, or when the **certificate** and measurement form(s) cannot be located by application of the procedure in A.9;
- (c) when one or more alternative **certificates** are requested to be valid concurrently with an existing **certificate** by application of the procedure in A.9.

A.13 RETENTION OF CERTIFICATION DOCUMENTATION

A.13.1 The **certification authority** shall:

- (a) retain the original documentation upon which the current **certificate** is based;
- (b) upon request, transfer this documentation to the new **certification authority** if the **hull** is exported.

Section B – Boat Eligibility

For a **boat** to be eligible for *racing*, it shall comply with the rules in this section.

B.1 CLASS RULES AND CERTIFICATION

B.1.1 The **boat** shall:

- (a) be in compliance with the **class rules**;
- (b) have a valid **certificate**; and
- (c) have valid **certification marks** as required.

B.2 CLASS ASSOCIATION MARKINGS

B.2.1 A valid Class Association Sticker, if required by the NCA or the ICA, shall be affixed to the **hull** in a conspicuous position.

Part 2 – REQUIREMENTS AND LIMITATIONS

The competitor and the **boat** shall comply with the rules in Part 2 when *racing*. In case of conflict Section C shall prevail.

Conformity with the rules of Section C is not checked as part of **certification control**.

The rules of Part 2 are **open class rules** in which anything not specifically prohibited by the **class rules** is permitted. Individual rules may require, limit, or prohibit as necessary.

Certification control, equipment inspection, and measurement at an event shall be carried out in accordance with the ERS except where varied in this Part and Part 3.

Section C – Conditions for Racing

C.1 GENERAL

C.1.1 RULES

The rules of Section B of the ERS shall not apply.

C.2 COMPETITOR

C.2.1 LIMITATIONS

- (a) One competitor only shall control the boat.
- (b) The competitor shall not be substituted during an event.

C.3 ADVERTISING

C.3.1 LIMITATIONS

The **boat** shall display only such advertising as permitted by the WS Advertising Code.

C.4 BOAT

C.4.1 FLOTATION

With the **boat** floating in fresh water, with slack rigging, in sailing condition and dry:

- (a) the forward waterline ending shall not fall forward of the aft edge of the forward waterline **limit mark**;
- (b) the aft waterline ending shall not fall aft of the forward edge of the aft waterline **limit mark**;
- (c) submerged parts of the **hull** shall not extend beyond the inboard edges of the waterline **limit marks**;
- (d) the waterline **limit marks** shall not be below the water surface.

C.4.2 DRAUGHT

The draught, measured to the datum waterplane, shall not exceed 700 mm.

C.4.3 WEIGHT

When carrying out **equipment inspection** or measurement at an event the weight of the **boat** in sailing condition, dry and with its heaviest rig shall be found using calibrated equipment and rounded to the nearest 0.01 kg. The weight shall be not more than the weight recorded on the **certificate** plus a tolerance of 0.05 kg.

C.4.4 LIMITATIONS

- (a) The **boat** shall sail with the **hull**, **hull appendages** and **ballast** used at the **certification control** relating to the **certificate** used for the event.
- (b) The **boat**, **rig** and **sails** shall comply with the dimensions recorded on the **certificate** used for the event.

C.5 HULL

C.5.1 LIMITATIONS

- (a) The **hull** shall not be substituted during an event.
- (b) Except for fittings the geometry of the **hull** shell shall not be changed during an event.

C.5.2 IDENTIFICATION

The **hull** registration number shall be displayed on the external surface of the **hull** clearly and legibly with a minimum height of 20 mm.

C.6 HULL APPENDAGES

C.6.1 LIMITATIONS

Except when a **hull appendage** has been lost or damaged beyond repair the same **hull appendages** shall be used during an event. Such replacement may be made only with the approval of the race committee who shall then remove or cancel any **event limitation mark** attached to the replaced **hull appendage**.

C.6.2 USE

- (a) The **hull appendages** shall not be attached to the **hull** more than 15 mm from the centreplane.
- (b) No part of any **hull appendage** shall cut the datum waterplane outboard of the waterline **limit marks**.
- (c) The **hull appendages** shall not be extended or retracted.

C.7 RIG

C.7.1 LIMITATIONS

- (a) Where the **certified rig** area is less than or equal to 10% of the maximum permitted sail area, the **rig** area of alternative rigs, found as in Section J, shall be less than or equal to the **certified rig** area.
- (b) Where the **certified rig** area is greater than 10% of the maximum permitted sail area, the cross widths of other spars found as in Section J shall comply with the **certificate**.

C.7.2 USE

- (a) The rig shall not project fore or aft of the **hull** in relation to the datum waterplane.
- (b) RRS 51 is changed to the extent that the position of the **boom** counterbalance weight may be changed.

C.8 SAILS

C.8.1 LIMITATIONS

- (a) For **hulls certified** on or after 1st July 2016 the dimensions of **sails** shall not exceed the dimensions of the **sails** recorded on the **certificate**.
- (b) With the exception that the **sail** may be moved vertically on the grid to achieve compliance, when carrying out **equipment inspection** or measurement at an event **sails** shall be **certified** as in Section K.
- (c) For **hulls** and **sails certified** before 1st July 2016 the profile of each alternative **sail** shall fall within the profile of the **sails** recorded on the **certificate**.
- (d) The minimum **luff** length of the largest **sail** of alternative rigs used when *racing* shall not be less than 990 mm.
- (e) For **sails** other than **soft sails**, the dimension given in C.8.1(c) applies to the distance from deck level to **top point**.

C.8.2 IDENTIFICATION

- (a) **Sail** identification shall comply with the RRS.
- (b) The class insignia shall be "10R" of dimensions: height 24–30 mm; width, except "1", 24–30 mm; thickness 5–8 mm and shall be displayed on the mainsail above a straight line between the **three-quarter leech point** and the nearest point on the **luff**.

C.8.3 USE

- (a) When a **sail** has a luff rope or spar sliders they shall be set in a spar track.
- (b) **Sails** shall not be reefed.

C.9 EQUIPMENT

C.9.1 PROHIBITED

- (a) Except where achieved by mechanical systems, automated control of **rig** and/or **sails**.
- (b) Except where achieved by mechanical systems, automated steering and/or navigation.
- (c) On board camera(s).
- (d) The use of pictures from any source while racing.
- (e) Except for the establishment and maintenance of a radio control link, control unit positioning information, signal strength, and battery status information, radio transmissions from the **boat** while *racing*.

C.9.2 USE

During an event, remote control and related equipment:

- (a) if temporarily removed, shall be refitted in the same position;
- (b) if replaced, shall be replaced by equipment of similar weight.

Section D – Hull

D.1 GENERAL

D.1.1 RULES

The **hull** shall either comply with the **class rules** in force at the time of its initial **certification control** or comply with the current **class rules**.

D.1.2 IDENTIFICATION

The **hull** registration number shall be marked in an easily visible location on a non-removable part of the **hull** by any of the following means: painting on, engraving in, bonding in, moulding in.

D.2 HULL

D.2.1 LIMIT MARKS

A forward and an aft waterline **limit mark** shall be placed on the outer surface of the **hull** across the centreplane, minimum size 30 mm long by 2 mm wide, and long enough to be easily visible with the boat afloat.

D.2.2 MATERIALS

- (a) Except in remote control equipment, the density of material shall not exceed that of lead (11,340 kg/m³).
- (b) The forward 15 mm shall be of elastomeric material.
- (c) From the foremost point of the **hull** to the point where the bow profile is 20 degrees to the datum waterplane, the vertical thickness of elastomeric material shall not be less than 5 mm.

D.2.3 CONSTRUCTION

- (a) The **hull** shall be a **monohull**.
- (b) With the following exceptions, hollows in the external surface of the **hull** are prohibited:
 - (1) transverse hollows in the undersurface of the **hull** that do not exceed 1 mm when tested parallel to the datum waterplane as in Figure L.6;
 - (2) other hollows 40 mm or more above the datum waterplane;
 - (3) 15 mm or less from the centreplane;
 - (4) trunking for **hull appendages**;
 - (5) inset transom and upper surface of deck;
 - (6) hollows which do not exceed 1 mm in depth when checked with a straight edge of length 300 mm.

Section E – Hull Appendages

E.1 GENERAL

E.1.1 RULES

Hull appendages shall comply with the current **class rules**.

E.2 HULL APPENDAGES

E.2.1 MATERIALS

The density of materials shall not exceed that of lead (11,340 kg/m³).

Section F – Rig

F.1 GENERAL

F.1.1 RULES

Rigs shall comply with the current **class rules**.

F.2 CERTIFIED RIG AREA

See Section J.

Section G – Sails

G.1 GENERAL

G.1.1 RULES

Sails shall comply:

- (a) with the **class rules** relating to the **certificate**; or

- (b) with the current **class rules**.

G.1.2 CERTIFICATION

The **official measurer** shall **certify sails** and add the following marks at the **tack**:

- (a) the date of **certification control**;
- (b) the area of each **sail** of the **certified rig** in square metres and rounded to three decimal places.;
- (c) on each alternative **sail**, the area of the parent **sail** in square metres and rounded to three decimal places.

G.1.3 LIMITATIONS

- (a) Of the **sails** of the **certified rig**, the largest **luff** length shall not exceed 2200 mm and shall not be less than 1990 mm.
- (b) For **sails** other than **soft sails**, the dimensions given in G.1.3(a) apply to the distance from deck level to **top point**.

G.1.4 CERTIFICATION CONTROL AND EQUIPMENT INSPECTION

During **certification control** and **equipment inspection**:

- (a) battens need not be removed;
- (b) **sails** may be attached to spars;
- (c) stays not exceeding 2 mm in diameter inside luff **tabling** need not be removed;
- (d) tell tales overlapping the **sail edges** shall be ignored;
- (e) **sails** shall be **certified** as trilateral **sails**;
- (f) parts of **stiffening** that are less than 2 mm in diameter and not covered by sail material shall not be taken as parts of the **sail**;
- (g) where a **sail** has a luff rope the cross widths shall be taken to the aft edge of the spar;
- (h) discontinuous attachments on the **luff** shall be disregarded provided that their total length, measured along the **luff**, does not exceed 10% of the **luff** length and that the longest attachment is no more than twice the shortest;
- (i) where the **sail** has no clearly defined **clew point**, ERS G.4 is altered and the **sail edges** shall be extended using a template with 900 mm radius as in Figure L.2.0;
- (j) where the **sail** has no clearly defined **tack point** a permanently marked point on the **luff** shall be used provided a line perpendicular to the **luff** and 25 mm below the **tack point** does not intersect the **sail** as in Figure L.2.0;
- (k) where the **sail** has no clearly defined **tack point**, and G.1.4(j) is not met, the **tack point** shall be taken as the point on the extended **luff** through which a line tangential to the **foot** and perpendicular to the **luff** passes. See Figure L.2.0.

G.2 CERTIFIED SAIL AREA

See Section K.

PART 3 – APPENDICES

The rules in Part 3 are **open class rules**. Measurement shall be carried out in accordance with the ERS except where varied in this part.

Section H – Rating and Weight

H.1 RATING FORMULA

Rating = $L \times S \times 8$

where L is the certified waterline length.

S is the sum of the **certified rig** area given in J.2 and the **certified** sail area given in K.1.

H.2 RATING

The **boat** shall have a rating no greater than 10.00.

H.3 WEIGHT

The weight of the **boat** in sailing condition, dry and with its heaviest rig shall be found using calibrated equipment, rounded to the nearest 0.01 kg and recorded on the measurement forms.

H.4 MEASUREMENTS AND CALCULATIONS

H.4.1 Linear measurements shall be taken in millimetres and rounded up to the nearest whole number before being recorded on the measurement forms and/or **certificate**, used in subsequent calculations or compared with a limiting value.

H.4.2 Maximum and minimum values of limitations in the **class rules** or **certificate** shall be taken as absolute limiting values.

H.4.3 Calculated values in millimetres or square millimetres shall be rounded to the nearest whole number before being recorded on a measurement form or **certificate**, used in any subsequent calculations or compared with any limitation in the **class rules** or **certificate**.

H.4.4 Calculated values in square metres shall be rounded to the nearest sixth place of decimals before being recorded on the **certificate**.

Section J – Rig Area

J.1 GENERAL

- (a) One **boom spar** with a maximum **boom spar cross section** not exceeding 22 mm may be used to extend the **tack** and/or **clew** of each **sail** without being included in the **certified rig** area.
- (b) A fitting shall be considered to be part of the spar when:

- (1) it is faired into the spar; or
- (2) it is bigger than is reasonably required for its purpose.

J.2 CERTIFIED RIG AREA

J.2.1 The **certified rig** area is the sum of the areas of the **rig** components of the largest rig,

excluding the items listed in J.2.2,

where if the sum of the area of the components does not exceed 10% of the maximum permitted sail area, the area of each component shall be found as in J.3 and/or J.4, or otherwise

where the area of each component shall be found as in K.3

- J.2.2
- (a) spars as in J.1(a).
 - (b) fittings as in J.1(b)
 - (c) **spreaders**.
 - (d) **rigging** with a maximum cross section of less than 2 mm.

J.3 CONSTANT AND EVENLY TAPERED PROFILES

J.3.1 CALCULATION

The area of the spar, A_m , is calculated as:

$$A_m = h \times (m_0 + m_n) / 2$$

where: h is the length of the spar above deck,

m_0 is the **fore-and-aft mast spar cross section** or **vertical boom spar cross section** at one end,

m_n is the **fore-and-aft mast spar cross section** or **vertical boom spar cross section** at the other end.

J.4 OTHER PROFILES

J.4.1 MEASUREMENT

- (a) **Mast spars** shall be placed over the measurement grid perpendicular to the grid lines and with a grid line at deck level. See Figure L.1.1 and L.1.2.
- (b) Other spars shall be placed over the measurement grid perpendicular to the grid lines and with a grid line at one end. See Figure L.1.3.
- (c) The **fore-and-aft mast spar cross sections** or **vertical boom spar cross sections**, m_0 to m_n , shall be measured at and along all the grid lines that the spar cuts.

J.4.2 CALCULATION

- (a) The area of spar above the uppermost gridline cutting the spar, A_t , is calculated as:

$$A_t = 0.7 \times m_n \times E$$

where E is the height of the spar above the uppermost grid line.

- (b) The area of the spar, A_m , is calculated as:
$$A_m = 100 (m_0 + m_n) + 200 (m_1 + m_2 + \dots m_{n-1}) + A_t$$

Section K – Sail Area

K.1 CERTIFIED SAIL AREA

The **certified** sail area is the sum of the area of the largest **sails** used together.

K.2 SOFT SAILS

K.2.1 GENERAL

With the exception of **double luff sails** this method shall be used for **soft sails**.

K.2.2 MEASUREMENT

- (a) The **sail** shall be placed over the measurement grid with the **clew point** on the datum grid line and with the **head point** and **tack point** on a line perpendicular to the grid lines. See Figure L.2.1.
- (b) If the **tack point** falls above the datum grid line on which the **clew point** is placed, the **sail** shall be moved vertically until the **tack point** is on the datum grid line. See Figure L.2.2.
- (c) The upper limit of area A_1 shall be marked at the **luff** and **leech** where they pass over the grid line. See Figure L.2.3.
- (d) Cross widths, c_0 to c_n , shall be measured from the **leech** to the **luff** at and along all the horizontal grid lines which the **sail** cuts. See Figure L.2.4.
- (e) Heights, h_0 to h_n , shall be measured from the datum grid line to the **foot** at and along all the vertical grid lines which the **sail** cuts. See Figure L.2.4.
- (f) Hollows in the **sail edges** shall be bridged by a straight line and cross widths and heights shall be taken to the bridging line. See Figure L.2.5.

K.2.3 CALCULATION

- (a) The major area, A_1 , is calculated as:
$$A_1 = 100 (c_0 + c_n) + 200 (c_1 + c_2 + \dots c_{n-1})$$
- (b) The head area, A_2 , is found from c_n , c_{n-1} and E using a calculation contained in the measurement form where E is the height of the **sail** above the uppermost grid line. See Figure L.5
- (c) The area below the **luff perpendicular**, A_3 , is calculated as:
$$A_3 = 25 (h_0 + h_n) + 50 (h_1 + h_2 + \dots) \quad (\text{See Figure L.2.1})$$
- (d) The sum of the areas, A_s , is calculated as:
$$A_s = A_1 + A_2 + A_3$$

K.3 OTHER SAILS AND RIG COMPONENTS

K.3.1 GENERAL

- (a) This method shall be used for:
 - (1) **sails** other than **soft sails**;
 - (2) **double luff sails**;
 - (3) **rig** components where the **certified rig** area, found using J.3 and/or J.4, exceeds 10% of the maximum permitted sail area; and
 - (4) combinations of the above items.
- (b) Small areas of supporting spar not enclosed by a **sail**, and end plates, shall be measured using Sections J and K if appropriate. Where the methods in Sections J and K are not appropriate, any suitable method may be used and the measurements and calculations shall be reported on the measurement form.
- (c) Each element of a group of elements, including those which retract into a parent, shall be measured as a separate item as in K.3.2. See Figure L.3.1.

K.3.2 MEASUREMENT

- (a) The element shall be placed over the measurement grid with the **clew point** on the datum grid line and with the **head point** and **tack point** on a line perpendicular to the grid lines. See Figure L.3.2.
- (b) If the **tack point** falls above the datum grid line on which the **clew point** is placed, the element shall be moved vertically until the **tack point** is on the datum grid line. See Figure L.3.3.
- (c) The **luff** and the **leech** shall be marked where they pass over the grid lines. See Figure L.3.3.
- (d) Skin girths, $2g_0$ to $2g_n$, shall be measured from the **leech** to the **luff** at and along all the horizontal grid lines which the element cuts. See Figure L.3.4.
- (e) The skin girth at each grid line shall be taken as the distance from the **leech**, round the surface of the element through the corresponding point on the **luff**, back to the same point. Any flaps shall be placed to give the greatest girth. See figure L.3.4.
- (f) Skin girths, $2h_0$ to $2h_n$ shall be measured from the datum grid line perpendicular round the **foot**. See Figure L.3.5.
- (g) Hollows in the element edges shall be bridged by a straight line and skin girths shall be taken to the bridging line. See Figure L.2.5.
- (h) The half girth, g_n or h_n , at a grid line is one half of the skin girth at that grid line.

K.3.3 CALCULATION

The area of the element, A_s , is calculated as in K.2.3 using half girths in place of cross widths and heights.

Section L – Figures

L.2.0 (EXTENSION OF SAIL EDGES)

Clew Point – G.1.4 (i)

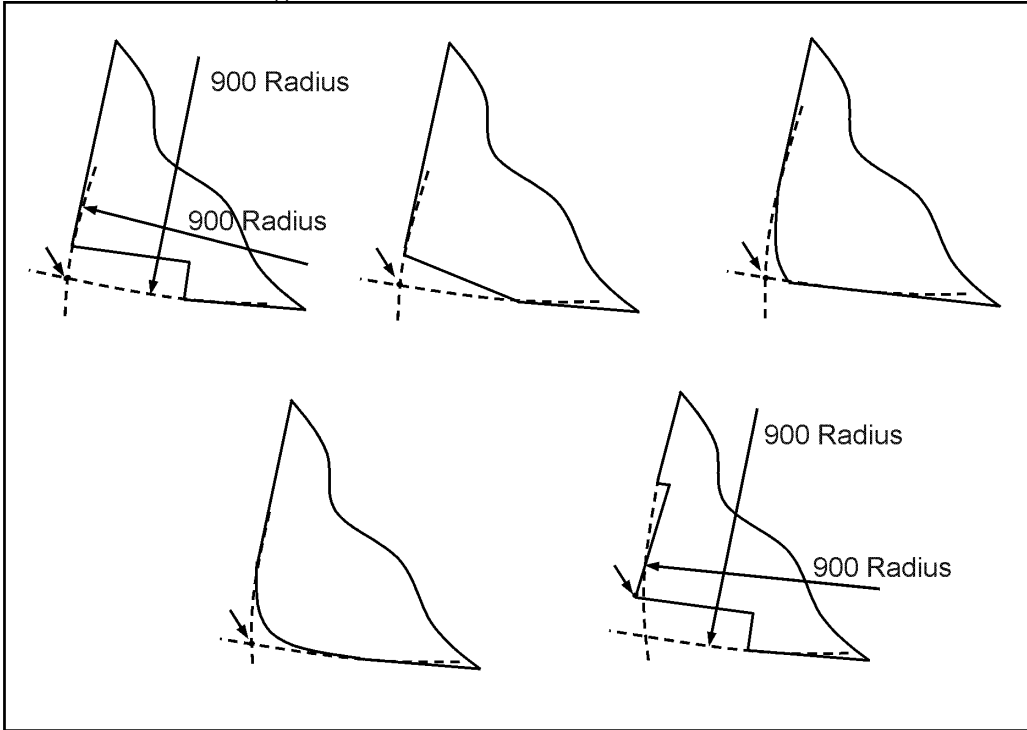

Tack Point – G.1.4 (j)

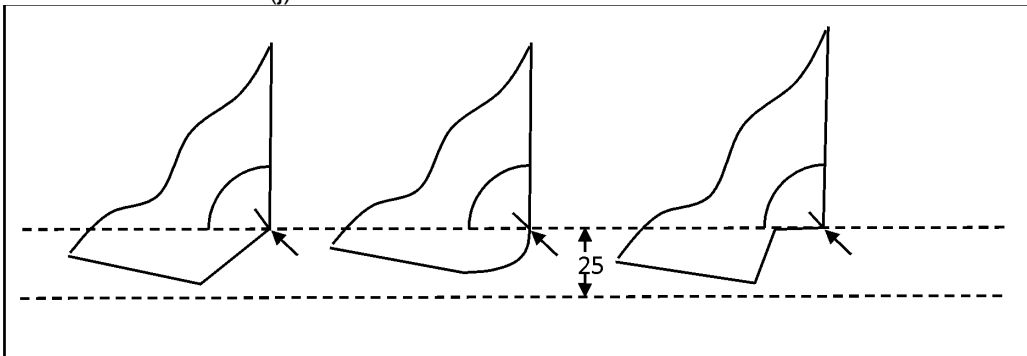

Tack Point – G.1.4 (k)

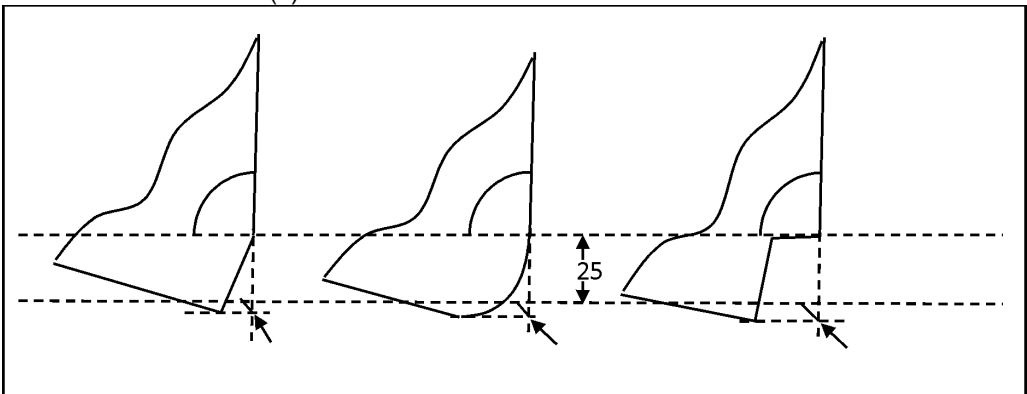

L.1 SPAR MEASUREMENT

L.1.1 (mast spar), L.1.2 (mast spar), L.1.3 (other spars)

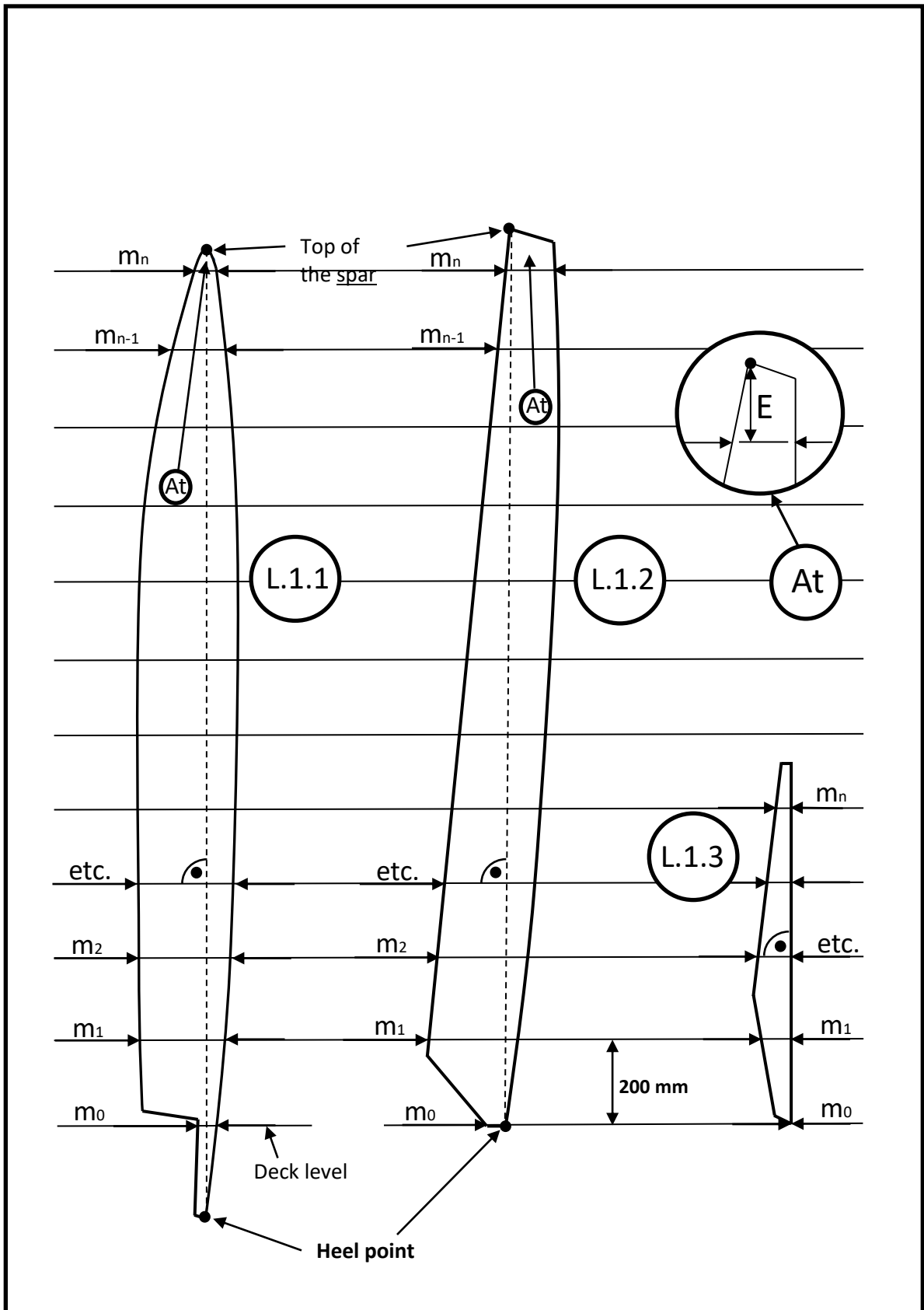

L.2. SOFT SAIL MEASUREMENTS

L.2.1 (sail on measurement grid), L.2.2 (clew below tack)

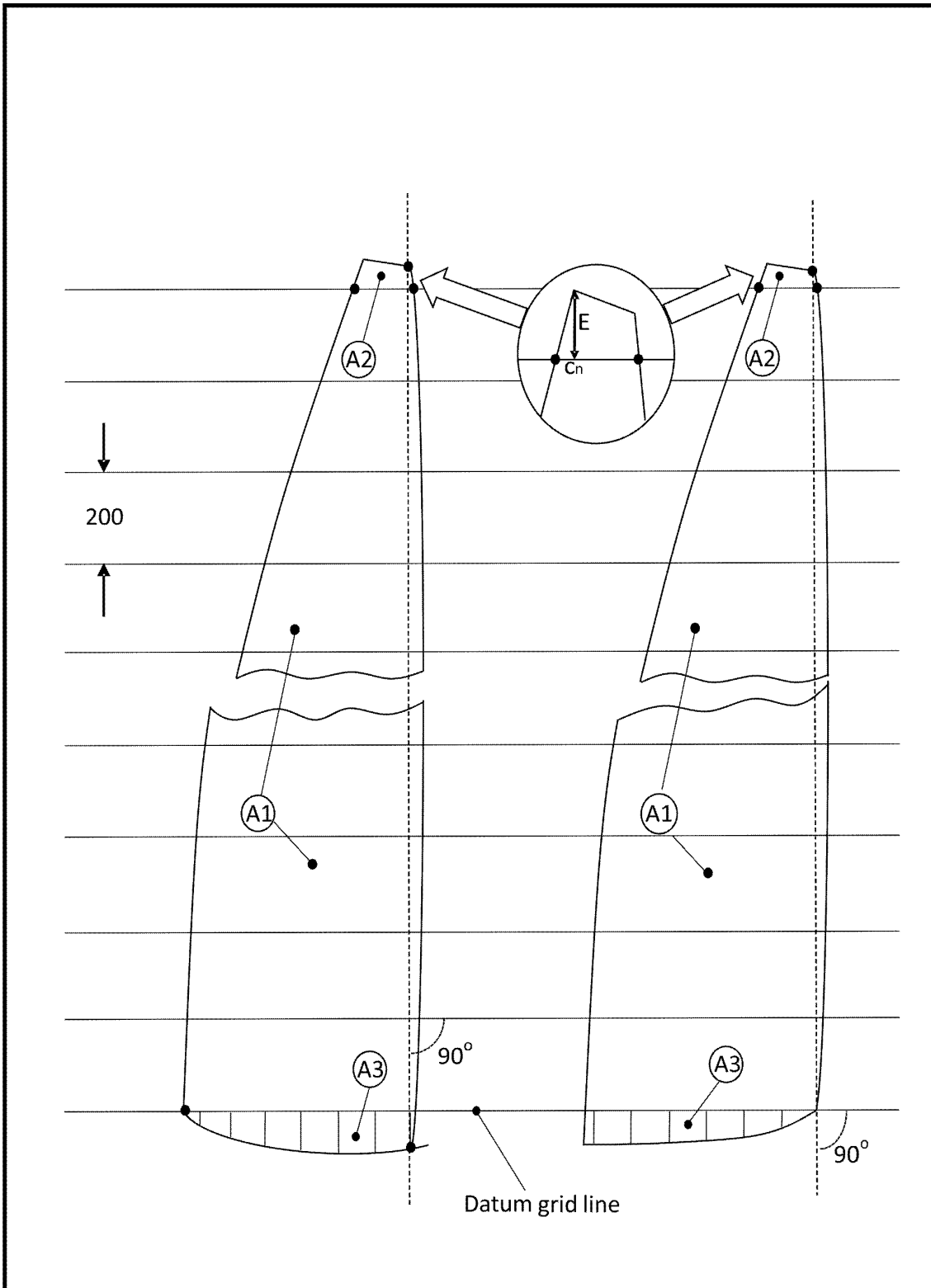

L.2 SOFT SAIL MEASUREMENTS continued

L.2.3 (mark upper limit of A1)

L.2.4 (measurements), L.2.5 (hollows in sail edges)

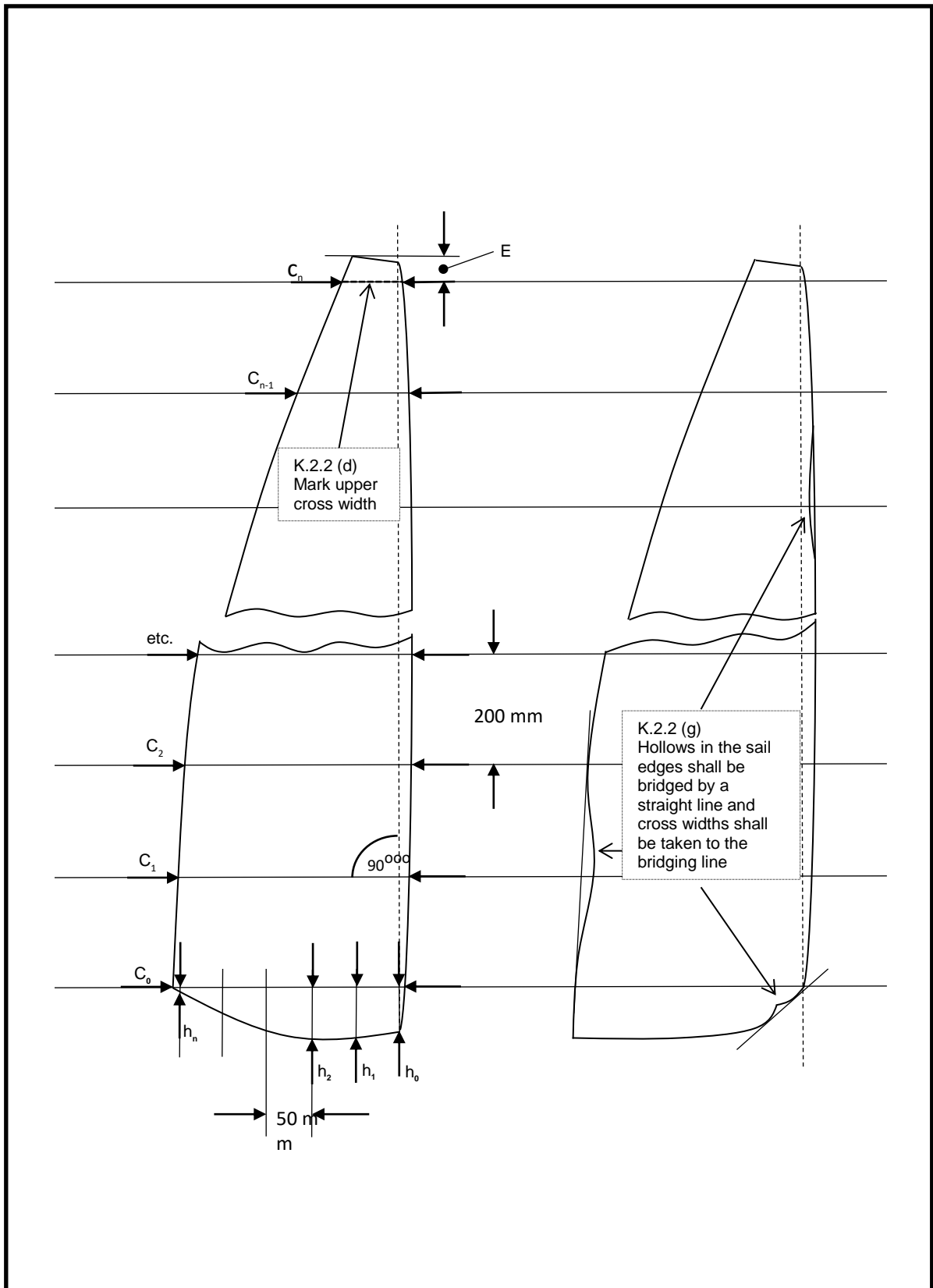

L.3 OTHER SAILS

L.3.1 (elements), L.3.4 (skin girth g), L.3.5 (skin girth h)

Figure L.3.1

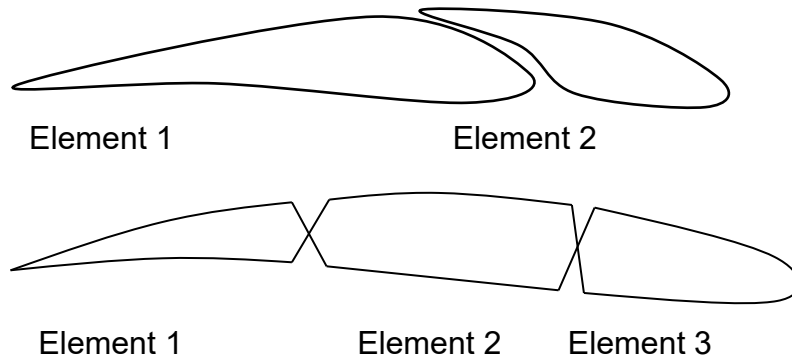

Figure L.3.4

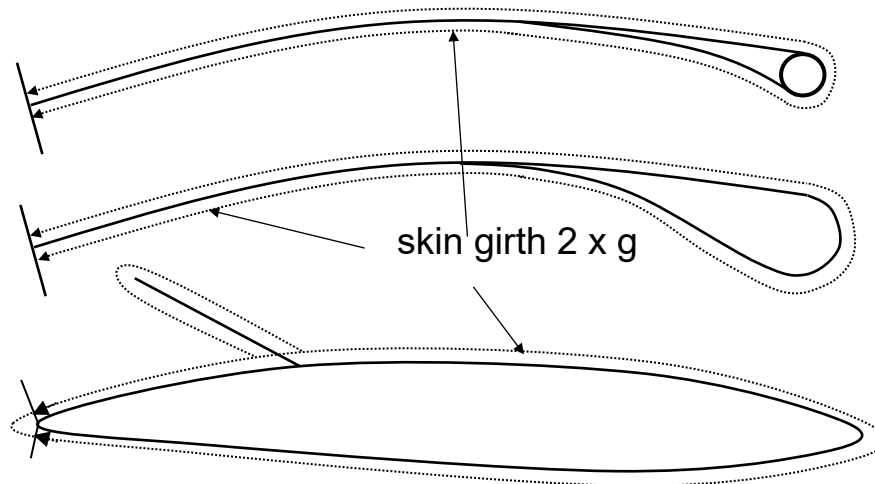
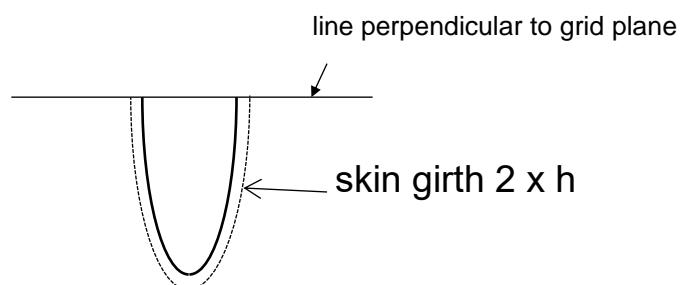
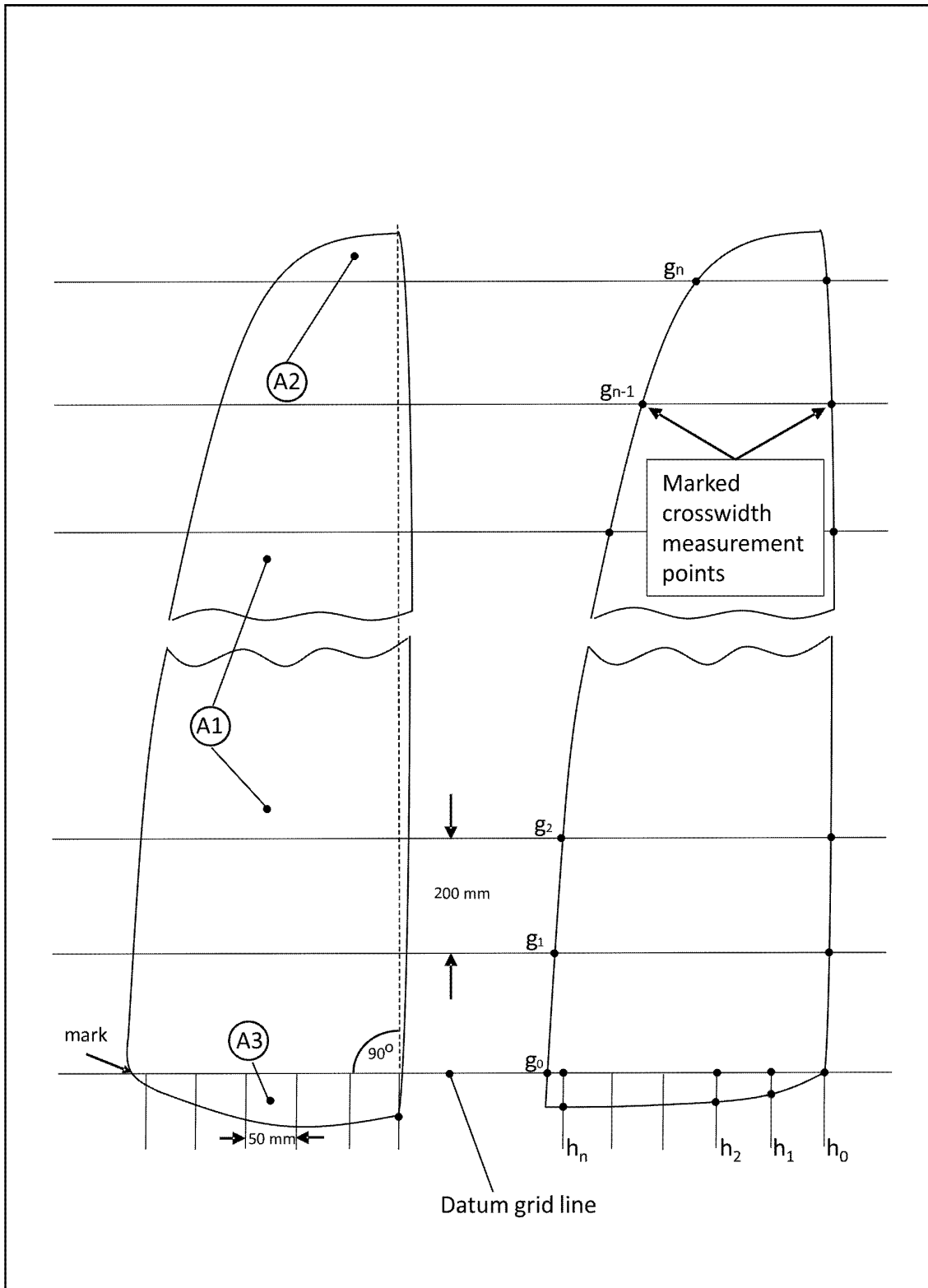

Figure L.3.5.



L.3 OTHER SAILS continued

L.3.2 (areas), L.3.3 (mark measurement points)



L.4. WATERLINE LIMIT MARKS ON PLUMB ENDED BOATS

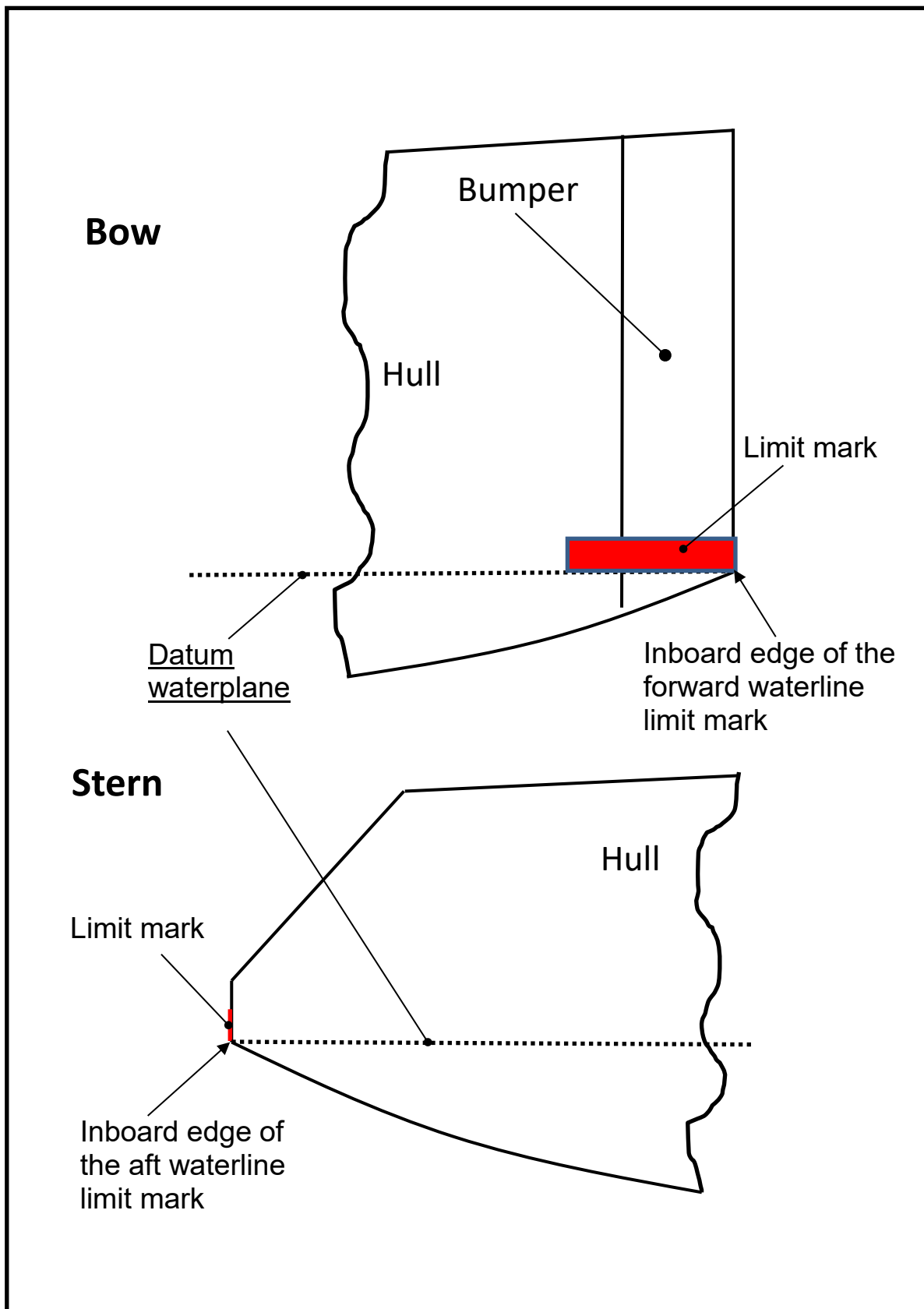

L.5. CALCULATION OF AREA A2

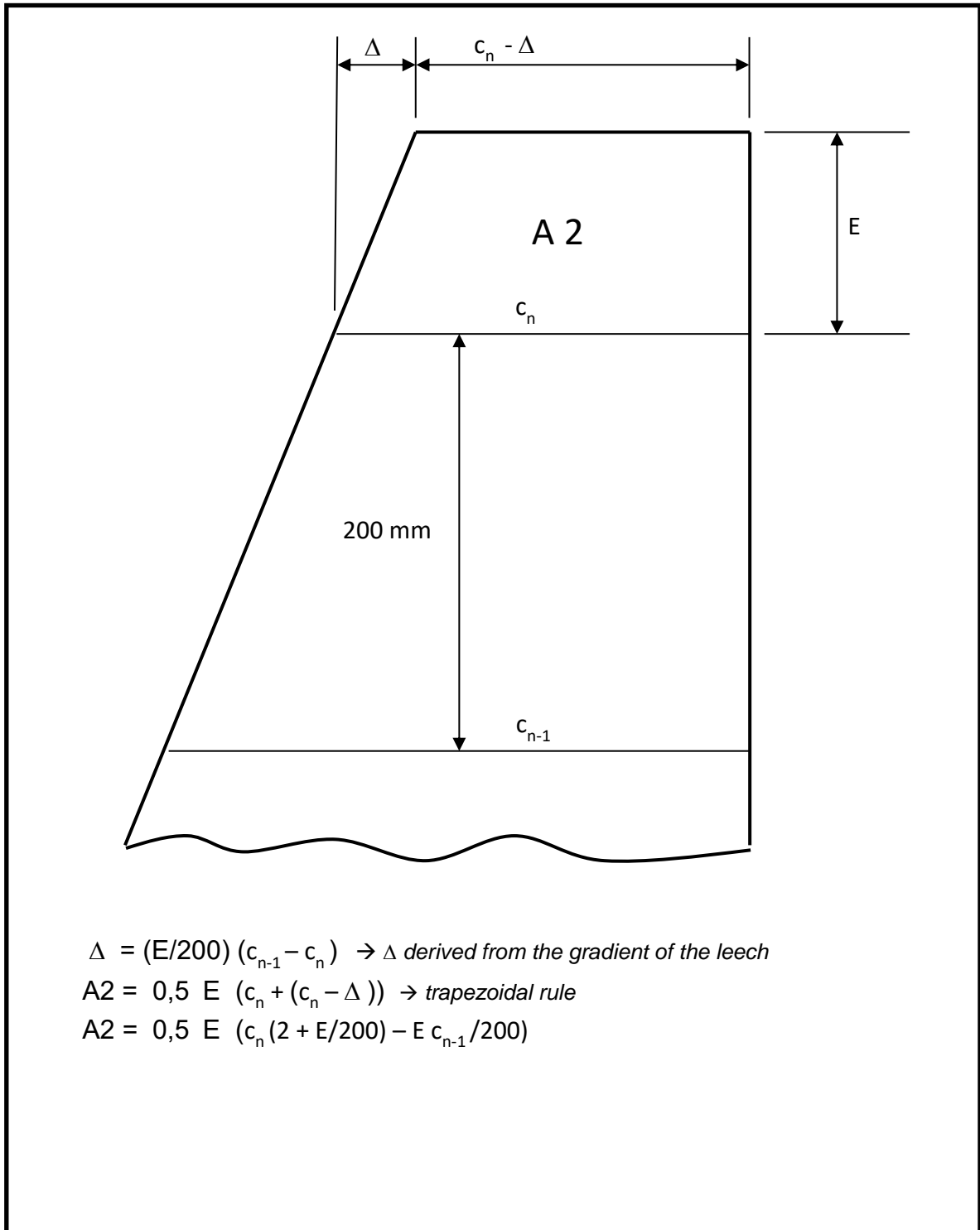

L.6 TRANSVERSE HULL HOLLOW

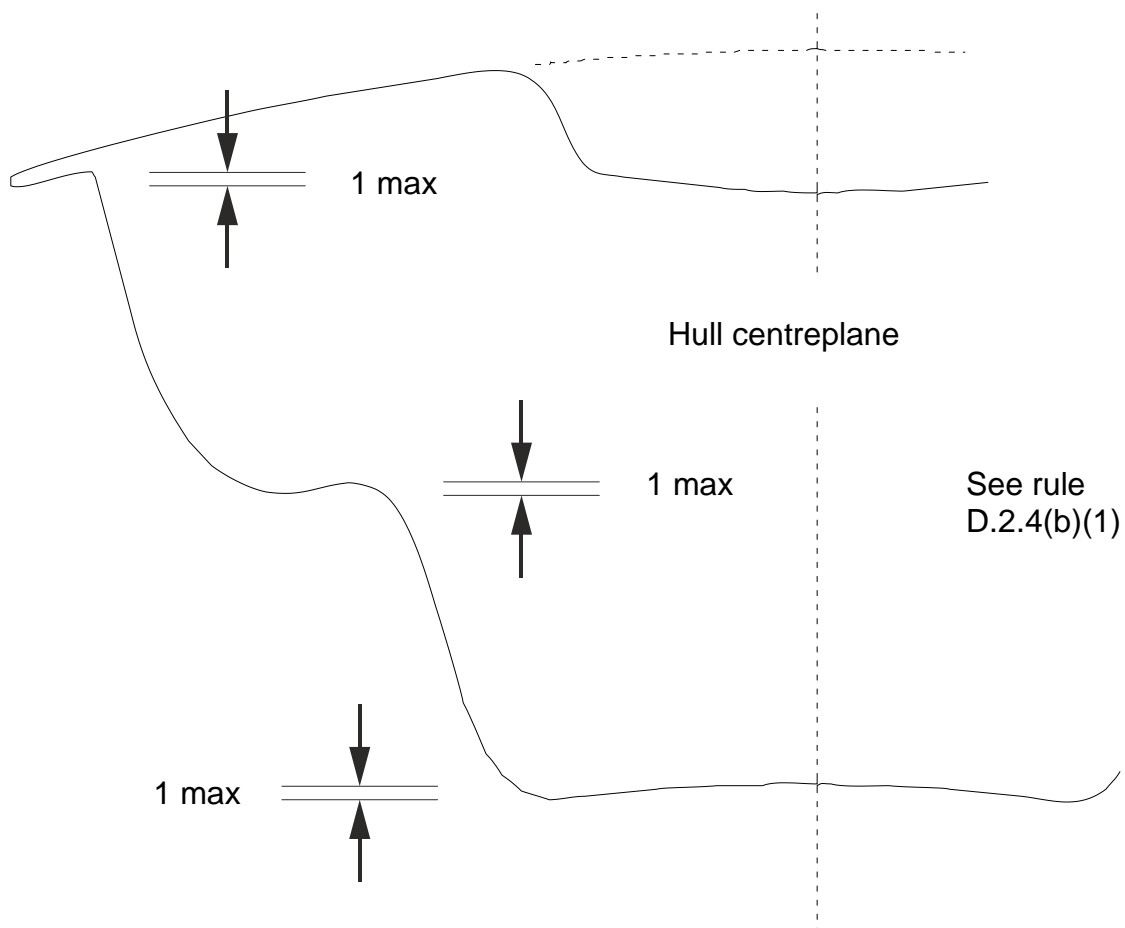

Effective: 1st April 2018
Published: 1st January 2018
Previous issue: March 2002; 1st April 2016

© 2018, International Radio Sailing Association